

SERVICE MANUAL

POWER AMPLIFIER
SANSUI BA-3000

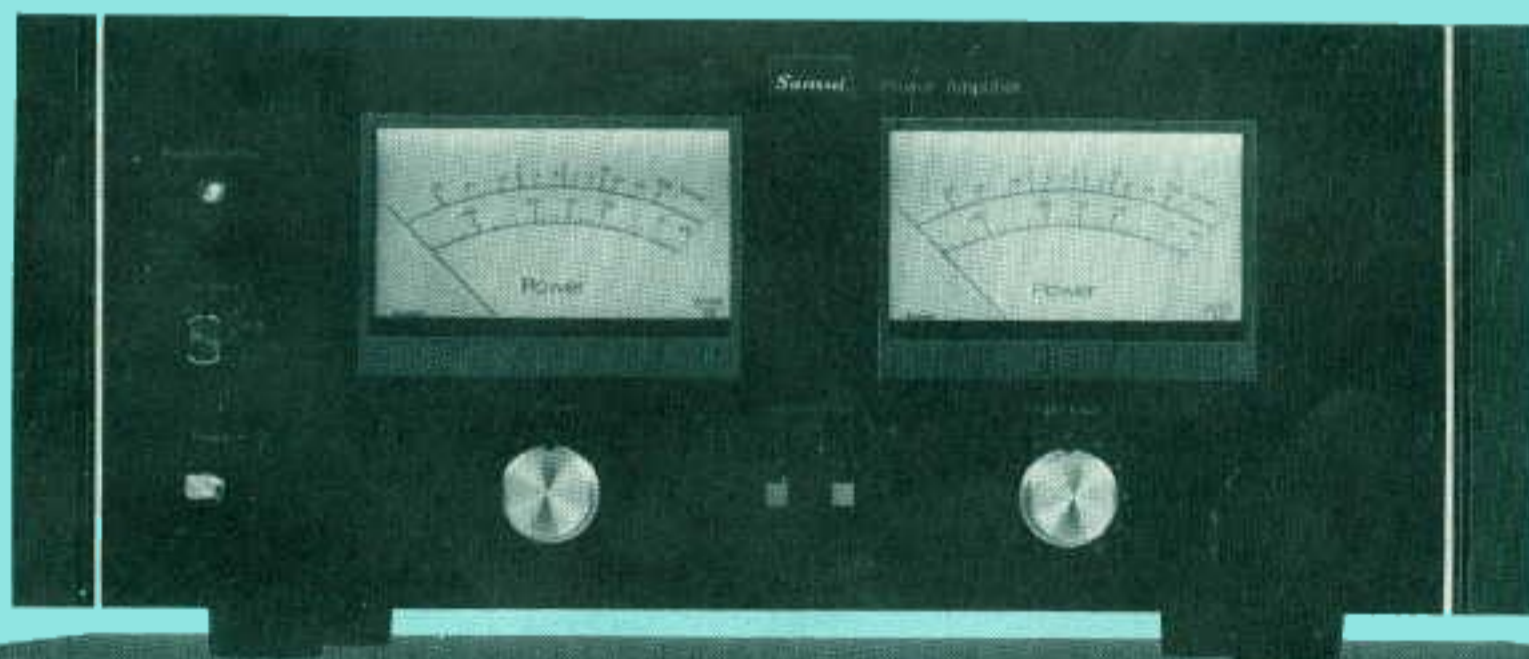

Sansui

SANSUI ELECTRIC CO., LTD.

ClassicSansui.net

1. SPECIFICATIONS

POWER OUTPUT

Min. RMS, both channels driven, 20 to 20,000Hz, with no more than 0.05% total harmonic distortion in stereo operation

- 170 watts per channel into 8 ohms
- 170 watts per channel into 4 ohms
- 85 watts per channel into 16 ohms

Min. RMS, both channels driven, at 1,000Hz, with no more than 0.05% total harmonic distortion in stereo operation

- 180 watts per channel into 8 ohms
- 170 watts per channel into 4 ohms
- 85 watts per channel into 16 ohms

Min. RMS, from 20 to 20,000Hz, with no more than 0.05% total harmonic distortion in mono (BTL) operation.

- 340 watts into 8 ohms
- 340 watts into 16 ohms

Min. RMS, at 1,000Hz, with no more than 0.05% total harmonic distortion in mono (BTL) operation

- 340 watts into 8 ohms
- 360 watts into 16 ohms

LOAD IMPEDANCE

In stereo operation 4, 8, 16 ohms

In mono (BTL) operation .. 8, 16 ohms

POWER BANDWIDTH 20 to 20,000Hz at or below rated min. RMS, power output and total harmonic distortion

TOTAL HARMONIC DISTORTION

..... less than 0.05% at or below rated min. RMS power output

INTERMODULATION DISTORTION

(70Hz : 7,000Hz = 4 : 1 SMPTE method)

..... less than 0.05%

FREQUENCY RESPONSE (at 1 watt)

..... 5Hz to 100kHz ± 1 dB

DAMPING FACTOR approximately 100 at 8 ohms load

CHANNEL SEPARATION (at rated output, 1kHz)

..... better than 60dB

HUM AND NOISE (IHF)

..... better than 100dB

INPUT SENSITIVITY AND IMPEDANCE

(1kHz, for rated output) .. 700mV 50k Ω

SUBSONIC FILTER

..... -3dB at 15Hz (12dB/oct)

GENERAL

POWER VOLTAGE 100, 120, 220, 240V 50/60Hz
120V (Usable 110—130V)
(for U.S.A. & Canada only)

POWER CONSUMPTION .. 1,100 watts (max.)
350 watts (rated)

DIMENSIONS 460mm (18 1/8") W

178mm (7 1/8") H

400mm (15 3/4") D

WEIGHT 22.6kg (49.8 lbs.) net

25.4kg (56.0 lbs.) packed

* Design and specifications subject to change without notice for improvements.

2. BLOCK DIAGRAM

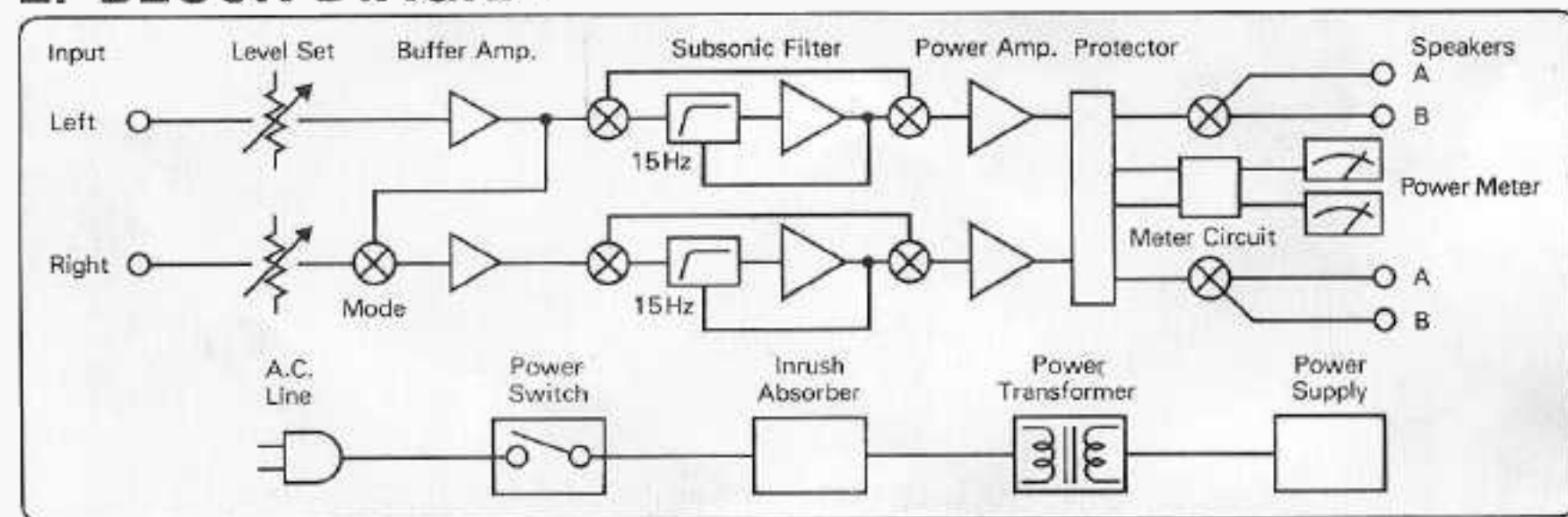

TABLE OF CONTENTS

Section	Title	Page	Section	Title	Page
1.	SPECIFICATIONS	2	5-5.	F-2506 Input Terminal Circuit Board	8
2.	BLOCK DIAGRAM	2	5-6.	F-2512 Connector Circuit Board	8
3.	ADJUSTMENTS	3	5-7.	F-2513 Filter Circuit Board	9
3-1.	Driver Circuit Board Adjustments	3	5-8.	F-2508 Power Supply Volume Circuit Board	10
3-2.	Power Meter Adjustment	3	5-9.	F-2515 Meter Amplifier Circuit Board	11
4.	TROUBLESHOOTING CHART	4	5-10.	F-2509 Circuit Board for installing connector	11
4-1.	Operation Block Diagram	4	5-11.	Figures	12
4-2.	Main Troubleshooting on Each Section	5	5-12.	Power Supply Voltage Changeover	12
5.	PARTS LOCATIONS AND PARTS LISTS	6	5-13.	Other Parts (Top, Bottom Side)	13
5-1.	F-2507 Driver Circuit Board	6	5-14.	Other Parts (Front Side)	14, 16
5-2.	F-2511 SP Protector Circuit Board	7, 8	6.	SCHEMATIC DIAGRAM	15
5-3.	F-2510 Circuit Board for installing emitter	8	7.	PACKING LIST	16
5-4.	F-2514 Meter Lamp Circuit Board	8	8.	ACCESSORY PARTS LIST	16

3. ADJUSTMENTS

3-1. Driver Circuit Board Adjustments (Fig. 1, 2, 3, 4)

- Note: 1. Master Volume..... Minimum
 2. Room Temperature..... 10~35°C
 3. For adjustment, run the unit for more than 5 minutes after the power is switched on.

STEP	SUBJECT	EQUIPMENT	MEASURE OUTPUT	ADJUST	ADJUST FOR	CONDITION
1.	DC 0V	DC Volt Meter	Speaker Terminal Fig. 4	F-2507 VR01 (Fig. 3)	0V ±10mV	VR02... Minimum (Counterclockwise) ※2)
2.	Bias Current	DC Volt Meter	F-2510 2-4 (Connector Pin) (Fig. 2)	F-2507 VR02 (Fig. 3)	20mV ※ 1)	

※ 1) Instead of measuring bias current, set the voltage to 20mV by VR02 between connector-pins 2 and 4 on both channels as Fig. 2, since there are no quick acting fuses in the power amplifier sections.

※ 2) On one channel, bias current, I_1 is current which flows into one power transistor, 2SC1585. Nemaaly, total current on one channel= $I_1 \times 3$

- L-CH..... TR01, TR05, TR09
 R-CH..... TR02, TR06, TR10

$$I_1 = \frac{V}{R_1 + R_2} = \frac{20}{0.94} \approx 20\text{mA}$$

$R_1, R_2 = 0.47\Omega$
 $V = 20\text{mV}$

Fig. 2

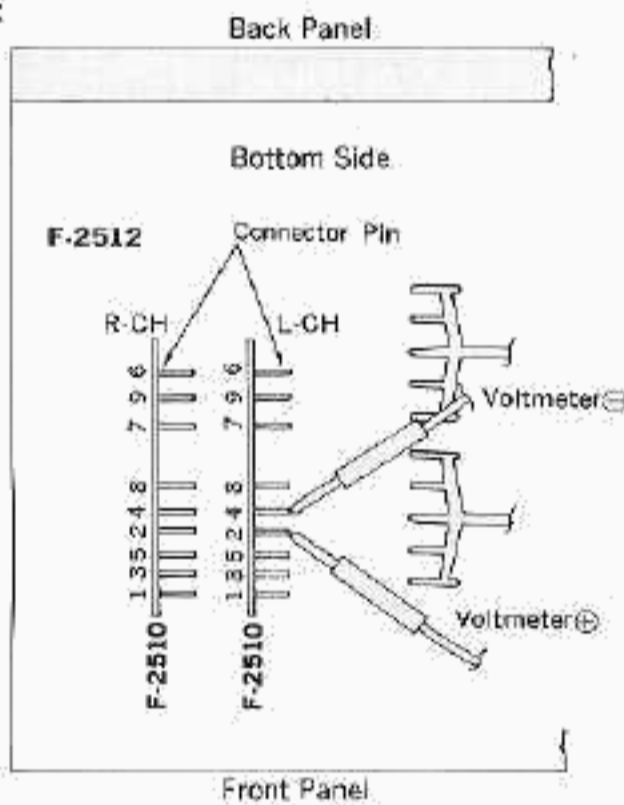

Fig. 3

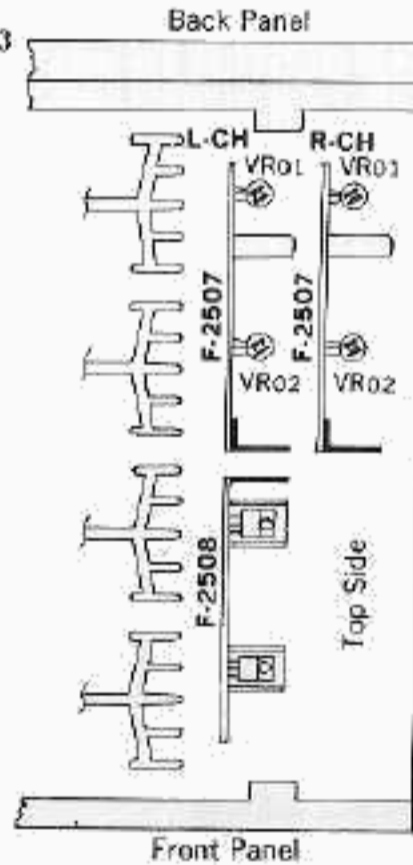
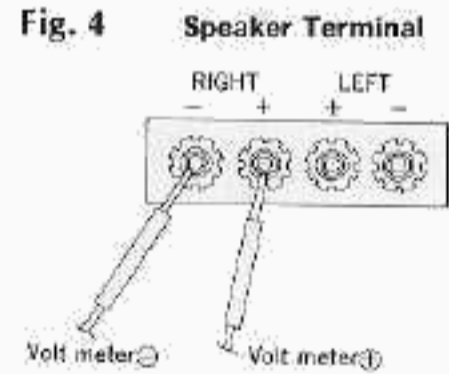

Fig. 4



3-2. Power Meter Adjustment (Fig. 5, 6, 7)

- Note: 1. Room Temperature..... 18~28°C
 2. Level Volume..... Maximum
 3. Input Signal..... Sine Curve (1kHz)
 4. Speaker load..... 8Ω
 5. For adjustment, run the unit for more than 5 minutes after the power is switched on.

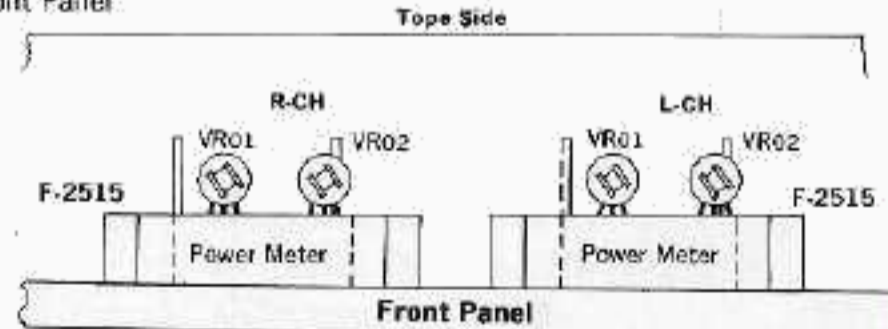

Fig. 7

STEP	SUBJECT	OUTPUT LEVEL	ADJUST	METER POSITION
1.	Power Meter Adjustment	36.9V (0dB) $\approx 170\text{Wp.e.}$	F-2515 VR02 Fig. 7)	0dB (Fig. 5)
2.	Power Meter Adjustment	369mV (-40dB)	F-2515 VR01 (Fig. 7)	-40dB (Fig. 6)
3.	Confirm the Step 1 again. If the meter position is not within 0dB ±1dB, repeat from step 1, 2.			

※ On both channels, above adjustments are necessary.

4. TROUBLESHOOTING CHART

4-1. Operation Block Diagram

The operation of each section is outlined in the block diagram shown below. Please utilize the diagram together with "Main Troubleshooting on Each Section" in this manual, if necessary.

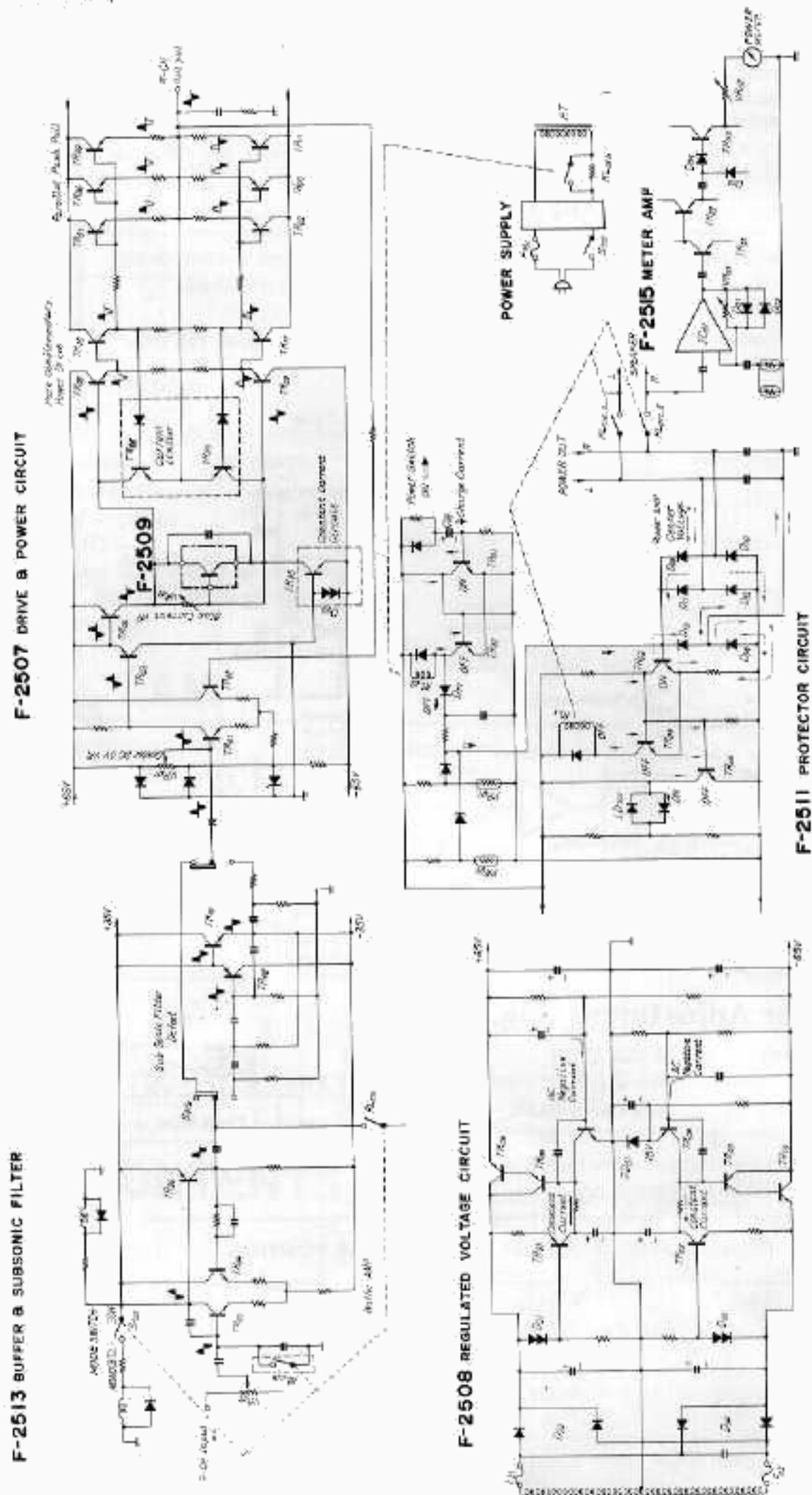

4-2. Main Troubleshooting on Each Section

1. Troubles on Power Supply Section

Symptom	Cause
1-1. Voltage $\pm B$ not supplied to F-2513, F-2515 or F-2507	
1) Defective AC line of power section	1. AC Fuse F701 open 2. Imperfect contact of AC switch, S702 3. R01 or R02 open on F-2511 4. Inoperative inrush absorber circuit
2) $\pm 85V$, Input voltage not supplied to F-2508	5. F01 or F02 open on F-2511 6. Defective D03 or D04 on F-2511
3) $\pm 35V$ not supplied to F-2513 and F-2515	7. Defective D01 or D02 on F-2508 8. Defective TR01, TR02 or TR05~TR11 on F-2508 9. Defective ZD01 on F-2508
4) $\pm 65V$ not supplied to F-2507	10. Defective D01 or D02 on F-2508 11. Defective TR03, TR04 or TR11~TR16 12. Defective ZD02 on F-2508

2. Troubles on Power Amplifier Section

2-1. Power Amplifier inoperative (Protector lamp lighted)	
1) AC Fuse opens	1. Power transistor shorted 2. TR01 opened on F-2509 3. TR10 or TR11 shorted on F-2507
2) AC fuse not opened	4. TR08 or TR09 shorted on F-2507 5. D06 or D07 shorted on F-2507 6. TR02, TR06 or TR07 shorted on F-2507
2-2. Inproper Bias Current	7. VR02 or VR03 out of adjustment or defective on F-2507 8. TR01 shorted on F-2509

3. Buffer Amplifier or Subsonic Filter Inoperative

1) Low and high filter inoperative	1. Imperfect contact of S01 on F-2513 2. Defective TR07~TR10 on F-2513
2) MONO (B.T.L.) circuit inoperative	3. Defective MODE switch S701 or relay RL01 4. Defective TR02, TR04 or TR06 on F-2513

4. Troubles on Power Meter Circuit

	1. VR01 or VR02 out of adjustment or F-2515 2. Defective IC01 or F-2515 3. Defective D01~D04 or F-2515 4. Defective TR01~TR03 or F-2515 5. Defective power meter.
--	---

5. Troubles on Speaker Protector Circuit

1) Relay, RL01 not switched OFF	1. Defective D09~D14 on F-2511 2. Defective TR03 or TR04 on F-2511 3. Defective relay, RL01
2) RL01 & RL02 not switched OFF at the moment when setting power switch to ON	4. Defective C08 on F-2511 5. Defective TR01 or TR02 on F-2511 6. Defective relay, RL02 7. RL01 inoperative due to defective D17 on F-2511
3) When power transistors overheat, protector relay RL01 inoperative	8. Defective posistor PR01 on F-2509
4) Protector indicator lamp not lighted	9. Defective TR05 on F-2511 10. Defective LED, LD701

*As each voltage of speaker protector circuit floats from chassis, it can not be measured to the earth point.

*Refer to Schematic Diagram.

5. PARTS LOCATIONS AND PARTS LISTS

5-1. F-2507 Driver Circuit Board (Stock No. 7571121 Complete Circuit Board F-2507)

Conductor Side

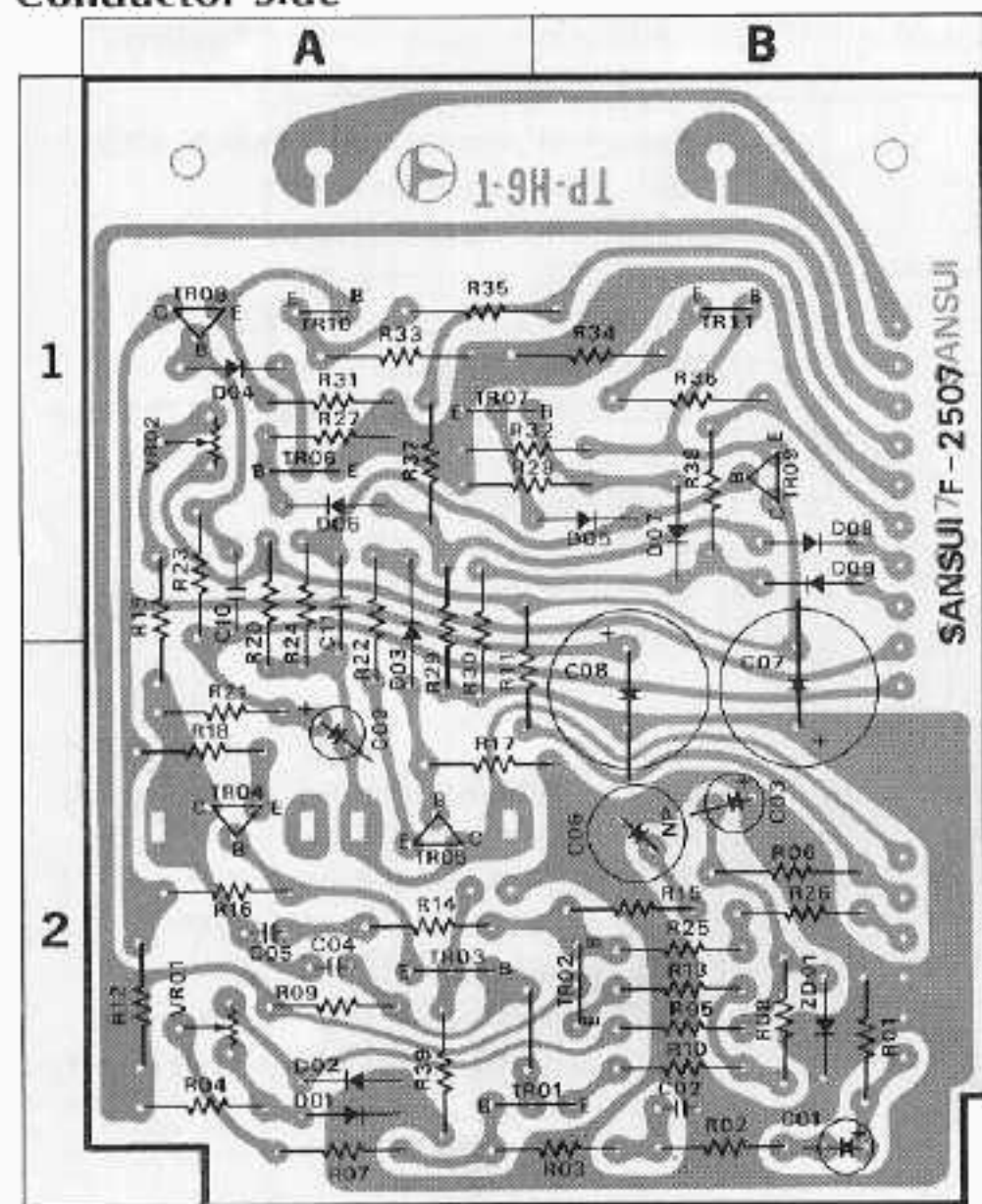

Parts No.	Stock No.	Description	Position
C01	0519102	3.3 μ F 50V E.C.	2B
C02	0660680	68pF 50V C.C.	2B
C03	0512470	47 μ F 16V E.C.	2B
C04	0660220	22pF	2A
C05	0660209	2pF	2A
C06	0530101	100 μ F 6.3V E.C.	2B
C07	0519903	100 μ F	1, 2B
C08	0519903	100 μ F	1, 2B
C09	0515339	3.3 μ F 50V E.C.	2A
C10	0657473	47000 pF	1A
C11	0657473	47000 pF	1, 2A
R01	0107224	220k Ω	2B
R02	0107472	4.7k Ω	2B
R03	0107102	1k Ω	2A, B
R04	0107682	6.8k Ω	2A
R05	0107822	8.2k Ω	2B
R06	0103103	10k Ω	2B
R07	0107104	100k Ω	2A
R08	0107682	6.8k Ω	2B
R09	0107472	4.7k Ω	2A
R10	0107101	100 Ω	2B
R11	0107331	330 Ω	1, 2A
R12	0107331	330 Ω	2A
R13	0107101	100 Ω	2B
R14	0107681	680 Ω	2A
R15	0107182	1.8k Ω	2B
R16	0107682	6.8k Ω	2A
R17	0107333	33k Ω	2A, B
R18	0107121	120 Ω	2A
R19	0107392	3.9k Ω	1, 2A
R20	0107102	1k Ω	1, 2A
R21	0107560	56 Ω	2A
R22	0107121	120 Ω	1, 2A
R23	0107391	390 Ω	1A
R24	0107391	390 Ω	1, 2A
R25	0107683	68k Ω	2B
R26	0107821	820 Ω	2B
R27	0107122	1.2k Ω	1A
R28	0107122	1.2k Ω	1A, B
R29	0107123	12k Ω	1, 2A
R30	0107123	12k Ω	1, 2A
R31	0107222	2.2k Ω	1A
R32	0107222	2.2k Ω	1A, B
R33	0103470	47 Ω	1A
R34	0103470	47 Ω	1A, B
R35	0103479	4.7 Ω	1A, B
R36	0103479	4.7 Ω	1B
R37	0107331	330 Ω	1A
R38	0107680	68 Ω	1B
R39	0107103	10k Ω	2A
VR01	1035350	4.7k Ω (B) Volume	2A
VR02	1035310	1k Ω (B) Volume	1A
	2420290	6P Connector A type	
	2420310	10P Connector A type	

Parts List

Parts No.	Stock No.	Description	Position
TR01	{ 0306270, 1 0306290, 1	2SC1708 (F, G) 2SC1400 (E, U)	2A, B
TR02	{ 0306270, 1 0306290, 1	2SC1708 (F, G) 2SC1400 (E, U)	
TR03	0300710, 1	2SA847 (F, G)	2A
TR04	{ 0300700, 1 0306260, 1	2SA818 (O, Y) 2SC1628 (O, Y)	2A
TR06	0305951, 2	2SC945 (Q, P)	
TR07	0300510, 1	2SA733 (P, Q)	1A, B
TR08	0306260, 1	2SC1628 (O)	1A
TR09	0300700, 1	2SA818 (O, Y)	1B
TR10	0306250-2	2SC1669LB (R, O, Y)	1A
TR11	0300690-2	2SA839LB (R, O, Y)	1B
D01	0311160	1S2473D	2A
D02	0311160	1S2473D	2A
D03	0340120	VD1212	2A
D04	0311160	1S2473D	1A
D05	0311160	1S2473D	1B
D06	0311160	1S2473D	1A
D07	0311160	1S2473D	1B
D08	0311160	1S2473D	1B
D09	0311160	1S2473D	1B
ZD01	{ 0316330 0316340	RD-15E B RD-15E C	2B

5-2. F-2511 SP Protector Circuit Board (Stock No. 7501111 Complete Circuit Board F-2511)

Conductor Side

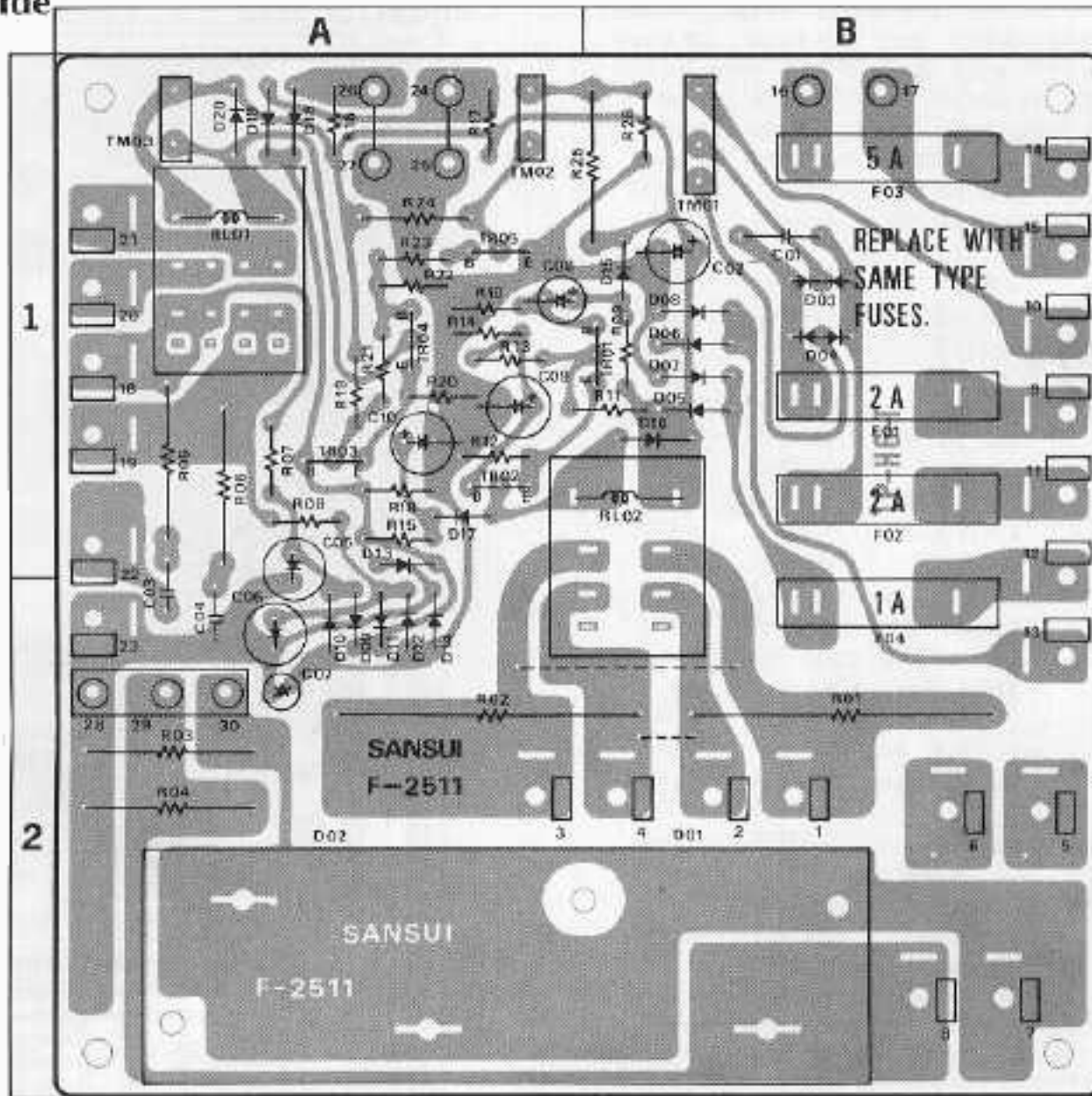

Parts List

Parts No.	Stock No.	Description	Position	Parts No.	Stock No.	Description	Position	
TR01	0306131-3	2SC1364 (6, 7, 8)	1 B	D16	0310340	10D1	1 B	
TR02	0306131-3	2SC1364 (6, 7, 8)	1 A	D17	0311160	1S2473D	1 A	
TR03	0306131-3	2SC1364 (6, 7, 8)	1 A	D18	0311160	1S2473D	1 A	
TR04	0306131-3	2SC1364 (6, 7, 8)	1 A	D19	0311160	1S2473D	1 A	
TR05	0306131-3	2SC1364 (6, 7, 8)	1 A	D20	0310340	10D1	1 A	
D01	0311440	SG5T-S	2 B	C01	0659011	10000pF 500V	C.C. 1 B	
D02	0311450	SG5T-R	2 A	C02	0515470	47µF 50V	E.C. 1 B	
D03	0310530	1S1850	1 B	C03, 04	0601108	0.1µF 50V	M.C. 12, A, 2A	
	0311420	C08P-2-N						
D04	0310540	1S1850R	1 B	C05	0530470	47µF ±30%	6.3V	1, 2 A
	0311430	C08P-2-R						
D05	0310340	10D1	1 B	C07	0535109	1µF 50V	E.C. 2 A	
D06	0310340	10D1	1 B	C08	0519102	3.3µF 50V	E.C. 1 A, B	
D07	0310340	10D1	1 B	C09	0510470	47µF 6.3V	E.C. 1 A	
D08	0310340	10D1	1 B					
D09	0311160	1S2473D	2 A	C10	0515100	10µF 50V	E.C. 1 A	
D10	0311160	1S2473D	2 A	C01	0659011	10000pF	500V	C.C.
D11	0311160	1S2473D	2 A					
D12	0311160	1S2473D	2 A					
D13	0311160	1S2473D	1 A					
D14	0311160	1S2473D	2 A	C02	0659011	10000pF	500V	C.C.
D15	0311160	1S2473D	1 B	C03	0659011	10000pF		
				C04	0659011	10000pF		
				C05	0659011	10000pF	25V	C.C.
				R01	0157399	3.9Ω 7W	Ca.R.	
				R02	0157399	3.9Ω 7W		
				R03	0202392	3.9kΩ 2W		Ca.R.

to be continued

F-2511

Parts No.	Stock No.	Description	Position
R04	0202392	3.9kΩ 2W	Co.R. 2A
R05, 06	0132479	4.7Ω 2W	
R07	0110473	47kΩ	1A
R08	0110473	47kΩ	1A
R09	0110273	27kΩ	1B
R10	0110182	1.8kΩ	1A
R11	0110123	12kΩ	1A, B
R12	0110100	10Ω	1A
R13	0110472	4.7kΩ	1A
R14	0110153	15kΩ	1A
R15	0110104	100kΩ	1/4 W S.R. 1A
R16	0110333	33kΩ	
R17	0110333	33kΩ	1A
R18	0110104	100kΩ	1A
R19	0110123	12kΩ	1A
R20	0110220	22Ω	1A
R21	0110472	4.7kΩ	1A
R22	0110153	15kΩ	1A
R23	0107122	1.2kΩ 1/2 W	C.R. 1A
R24	0103181	1.8kΩ 1/2 W	C.R. 1A
R25	0162561	560Ω 2 W	Ce.R. 1B
R26	0107221	220Ω 1/4 W	C.R. 1B
RL01	1150101	MY4-02-U5 Relay Switch	1A
RL02	1150310	LY2-0-Y34 Relay Switch	1A, B
F01	0431242	2A 250V	AC Fuse 1B
F02	0431242	2A 250V	
F03	0431282	5A 250V	
F04	0431222	1A 250V	
	2310051	P Type Fuse Holder	2B
	2410580	3P Pin Ass'y D type	

5-3. F-2510 Circuit Board for installing emitter

(Stock No. 7592611 Complete Circuit Board F-2510)

Parts No.	Stock No.	Description
	2410760	3P Pin Ass'y C type
	2410780	6P Pin Ass'y C type

5-4. F-2514 Meter Lamp Circuit Board

(Stock No. 7592641 Complete Circuit Board F-2514)

Parts No.	Stock No.	Description
PL01-03	0420050	7V 320MA Pilot Lamp
	2310051	P Type Fuse Holder

5-5. F-2506 Input Terminal Circuit Board

(Stock No. 7592591 Complete Circuit Board F-2506)

5-6. F-2512 Connector Circuit Board

(Stock No. 7592921 Complete Circuit Board F-2512)

Conductor Side

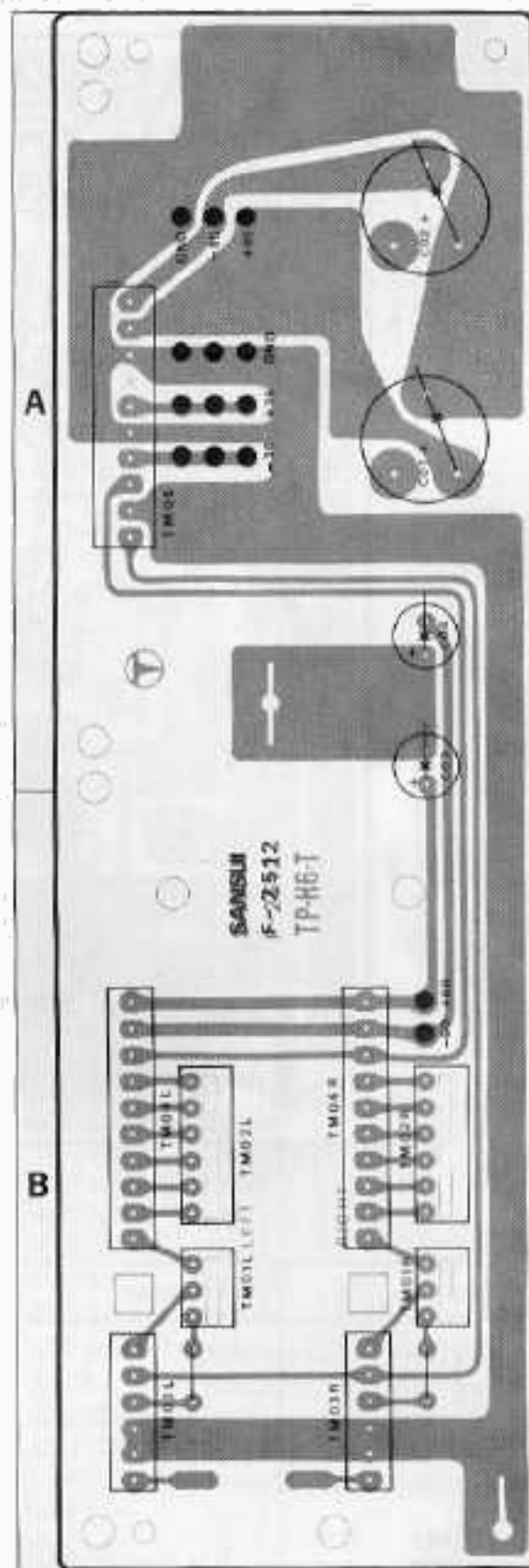

Parts List

Parts No.	Stock No.	Description	Position
C01	0549401	470μF	100V E.C. A
C02	0549401	470μF	
C03	0519401	22μF	
C04	0519401	22μF	
	2410730	6P Pin Ass'y A type	A, B
	2410750	10P Pin Ass'y A type	
	2410880	10P Pin Ass'y B type	A
	2420320	3P Connector A type	
	2420340	6P Connector A type	

5-7. F-2513 Filter Circuit Board (Stock No.: 7592631 Complete Circuit Board F-2513)

Conductor Side

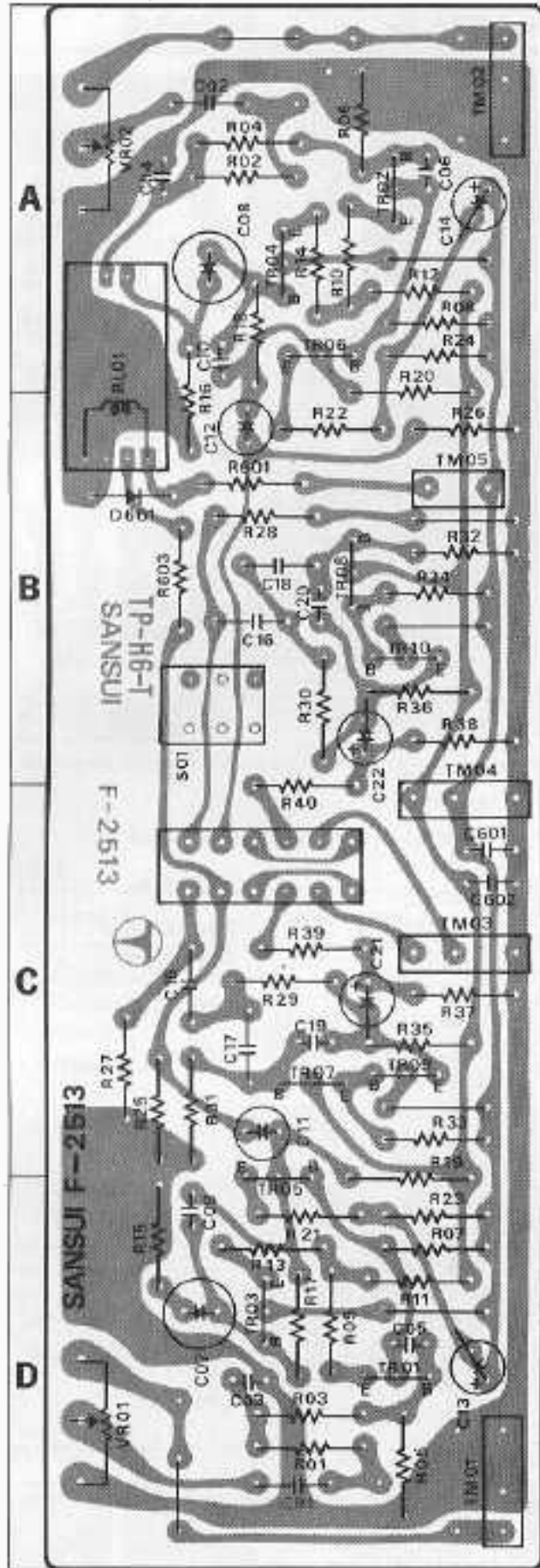

Parts List

Parts No.	Stock No.	Description	Position
TR01, 02	0306071, 2	2SC1313 (G, H)	} Transistor D, A D, A C, D, A C, B C, B
TR03, 04	0306071, 2	2SC1313 (G, H)	
TR05, 06	0300720, 1	2SA850 (C, D)	
TR07, 08	0300470, 1	2SA726 (F, G)	
TR09, 10	0306270, 1	2SC1708 (F, G)	
D601	0310340	10D-1 (1S2226)	B
C01, 02	0401228	0.22 μ F 50V M.C.	C, A
C03, 04	0460330	33pF } 50V C.C.	C, A
C05, 06	0460100	10pF } 50V C.C.	C, A
C07, 08	0530470	47 μ F 6.3V E.C.	C, A
C09, 10	0660100	10pF 50V C.C.	C, A
C11, 12	0533339	3.3 μ F 25V E.C.	C, B
C15, 16	0600228	0.22 μ F } 50V M.C.	C, B
C17, 18	0600228	0.22 μ F } 50V M.C.	C, B
C19, 20	0660151	150pF 50V	C, B
C21, 22	0533339	3.3 μ F 25V E.C.	C, B
C602	0657473	47000pF } 50V C.C.	C
C603	0657473	47000pF } 50V C.C.	
R01, 02	0107332	3.3k Ω } $\frac{1}{4}$ W C.R.	D, A
R03, 04	0107102	1k Ω } $\frac{1}{4}$ W C.R.	D, A
R05, 06	0107474	470k Ω	D, A
R07, 08	0107473	47k Ω	D, A
R09, 10	0107560	56 Ω	D, A
R11, 12	0107124	120k Ω } $\frac{1}{4}$ W C.R.	D, A
R13, 14	0107560	56 Ω	D, A
R15, 16	0107104	100k Ω	D, A, B
R17, 18	0107473	47k Ω	D, A
R19, 20	0103822	8.2k Ω } $\frac{1}{2}$ W C.R.	C, D, A, B
R21, 22	0107470	47 Ω	D, B
R23, 24	0107821	820 Ω	D, A
R25, 26	0107473	47k Ω	D, B
R27, 28	0107473	47k Ω	D, B
R29, 30	0107273	27k Ω	D, B
R31, 32	0107823	82k Ω } $\frac{1}{4}$ W C.R.	D, B
R33, 34	0107334	330k Ω } $\frac{1}{4}$ W C.R.	D, B
R35, 36	0107183	18k Ω	D, B
R37, 38	0107473	47k Ω	D, B
R39, 40	0107222	2.2k Ω	D, B, C
R601	0107681	680 Ω	B
R603	0107473	47k Ω	B
RL01	1150320	HA-224N Relay Switch	A, B
VR01, 02	1000330, 1	100k Ω (B) Volume	D, A
S01	1131090	Push Switch	B
	2410580	3P Ptn Ass'y D type	
	2410650	2P Ptn Ass'y D type	

5-8. F-2508 Power Supply Voltage Circuit Board (Stock No. 7501101 Complete Circuit Board F-2508)

Conductor Side

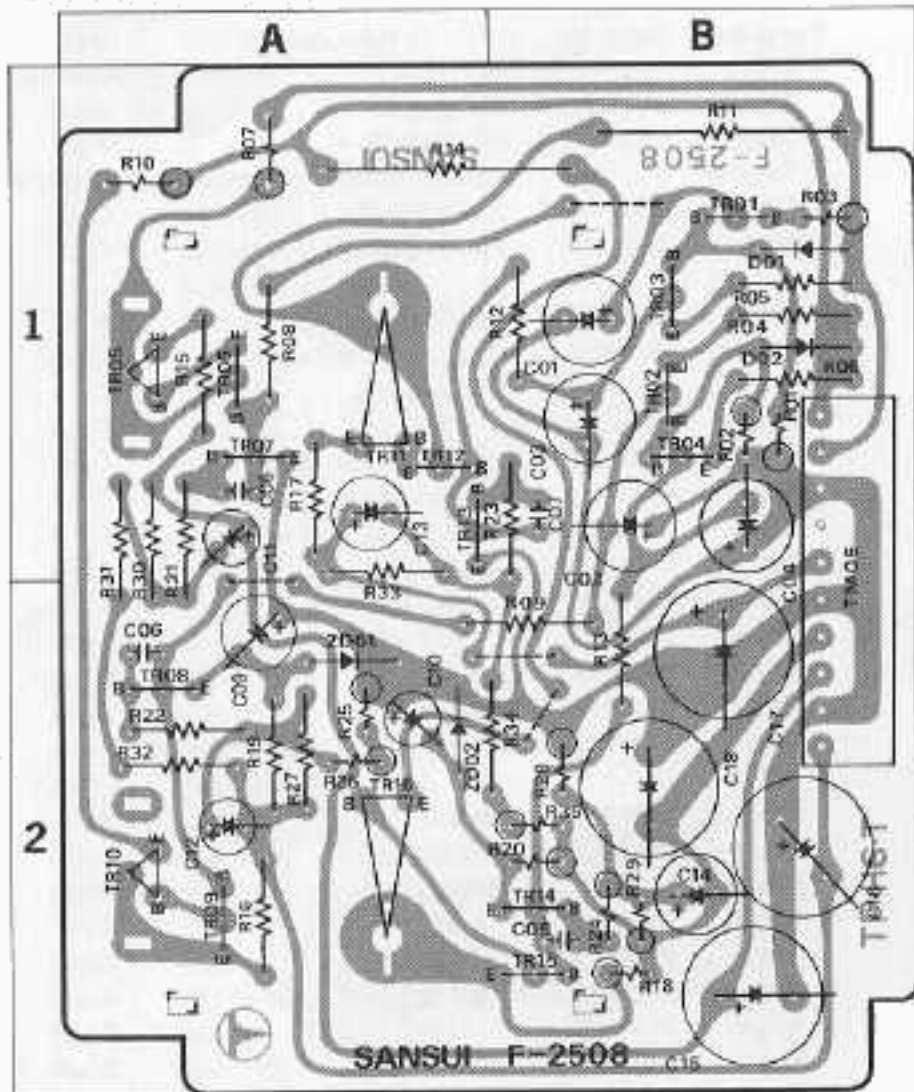

Parts No.	Stock No.	Description	Position
C01	0519404	10 μ F } 100V E.C.	1B
C02	0519404	10 μ F }	1B
C03	0515470	47 μ F } 50V E.C.	1B
C04	0515470	47 μ F }	1B
C05	0660101	100 pF }	1A
C06	0660101	100 pF }	2A
C07	0660101	100 pF } 50V C.C.	1B
C08	0660101	100 pF }	2B
C09	0512330	33 μ F } 16V E.C.	2A
C10	0512330	33 μ F }	2A
C11	0519403	2.2 μ F } 100V E.C.	1A
C12	0519403	2.2 μ F }	2A
C13	0515100	10 μ F } 50V E.C.	1A
C14	0515100	10 μ F }	2B
C15	0519302	220 μ F } 75V E.C.	2B
C16	0519302	220 μ F }	2B
C17	0515331	330 μ F } 50V E.C.	2B
C18	0515331	330 μ F }	2B
R01	0106473	47k Ω }	1B
R02	0106473	47k Ω }	1B
R03	0106122	1.2k Ω } 1/4 W C.R.	1B
R04	0107122	1.2k Ω }	1B
R05	0107561	560 Ω }	1B
R06	0107561	560 Ω }	1B
R07	0162151	150 Ω } 2 W Co.R.	1A
R08	0107822	8.2k Ω } 1/4 W C.R.	1A
R09	0107822	8.2k Ω }	2A, B
R10	0162151	150 Ω } 2 W Co.R.	1A
R11	0185331	330 Ω } 5 W Co.R.	1B
R12	0107123	12k Ω } 1/4 W C.R.	1B
R13	0107123	12k Ω }	2B
R14	0185331	330 Ω } .5 W	1A, B
R15	0107100	10 Ω }	1A
R16	0107100	10 Ω }	2B
R17	0107100	10 Ω }	1A
R18	0106100	10 Ω }	2B
R19	0107223	22k Ω }	2B
R20	0106103	10k Ω }	2B
R21	0107562	5.6k Ω }	1, 2A
R22	0107562	5.6k Ω }	2B
R23	0107562	5.6k Ω }	1B
R24	0106562	5.6k Ω }	1B
R25	0106182	1.8k Ω } 1/4 W C.R.	2A
R26	0106123	12k Ω }	2B
R27	0107473	47k Ω }	2B
R28	0106153	15k Ω }	2B
R29	0106183	18k Ω }	2B
R30	0107563	56k Ω }	1, 2A
R31	0107102	1k Ω }	1, 2A
R32	0107563	56k Ω }	2B
R33	0107333	33k Ω }	1A
R34	0107102	1k Ω }	2A, B
R35	0107333	33k Ω }	2B
	2420310	10P Connector A type	

Parts List

Parts No.	Stock No.	Description	Position
TR01	0300720	2SA850 (C, D)	1B
TR02	0306280, 1	2SC1735 (C, D)	1B
TR03	0300720, 1	2SA850 (C, D)	1B
TR04	0306280, 1	2SC1735 (C, D)	1B
TR05	0308431-3	2SD381 (M, L, K)	1A
TR06	0306280, 1	2SC1735 (C, D)	1A
TR07	0306270, 1	2SC1708 (F, G)	1A
TR08	0300710, 1	2SA847 (F, G)	2A
TR09	0300720	2SA850 (C, D)	2A
TR10	0308431-3	2SD381 (M, L, K)	2A
TR11	0308441-3	2SD382 (M, L, K)	1A
TR12	0306280, 1	2SC1735 (C, D)	1A
TR13	0306071, 2	2SC1313 (G, H)	1A
TR14	0300470, 1	2SA726 (F, G)	2B
TR15	0300720, 1	2SA850 (C, D)	2B
TR16	0308441-3	2SD382 (M, L, K)	2A
		Transistor	
D01	0340120	VD1212 } Diode	1B
D02	0340120	VD1212 }	1B
ZD01	0316340	RD-15E C } Diode	2A
ZD02	0316340	RD-15E C }	2A

5-9. F-2515 Meter Amplifier Circuit Board (Stock No. 7592651 Complete Circuit Board F-2515)

Conductor Side

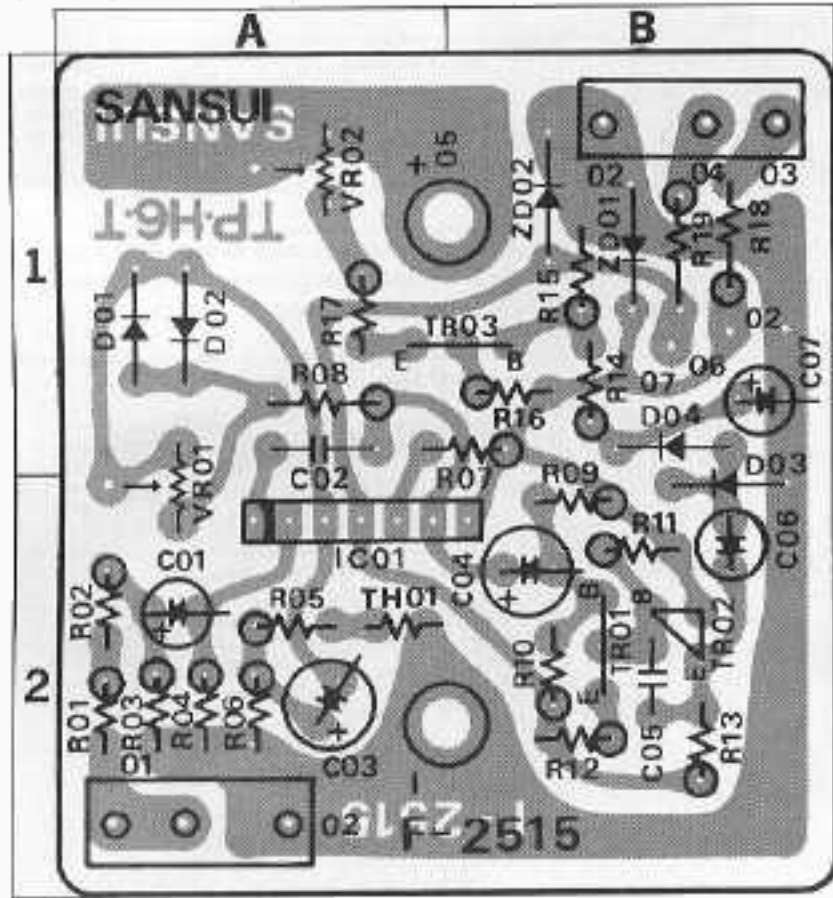

Parts List

Parts No.	Stock No.	Description	Position
TR01	0305951, 2	2SC945 (Q, P)	} Transistor
TR02	0305951, 2	2SC945 (G, P)	
TR03	{ 0306071 0306161	{ 2SC1313 (G) 2SC1312 (F)	
IC01	0360280	TA-7136P IC	2A, B
D01	0340120	VD1212	} Diode
D02	0340120	VD1212	

Parts No.	Stock No.	Description	Position
D03	0311160	1S2473D	} Diode
D04	0311160	1S2473D	
ZD01	{ 0316330 0316340	{ RD-15E (B) RD-15E (C)	} Diode
ZD02	{ 0316330 0316340	{ RD-15E (B) RD-15E (C)	
C01	0515109	1µF 50V E.C.	2A
C02	0660100	10µF 50V C.C.	1A
C03	0513100	10µF	} 25V E.C.
C04	0513100	10µF	
C05	0660151	150µF 50V C.C.	2B
C06	0435109	1µF 50V E.C.	2B
C07	0573688	0.68µF 35MV T.C.	1B
C08	0660390	33µF 50V C.C.	
R03	0106101	100Ω	2A
R04	0106154	150kΩ	2A
R05	0106102	1kΩ	2A
R06	0106272	2.7kΩ	2A
R07	0106104	100kΩ	1A, B
R08	0106821	820Ω	1A
R09	0106474	470kΩ	2B
R10	0106563	56kΩ	} 1/4W C.R.
R11	0106183	18kΩ	
R12	0106332	3.3kΩ	
R13	0106392	3.9kΩ	
R14	0106684	680kΩ	
R15	0106474	470kΩ	
R16	0106182	1.8kΩ	
R17	0106471	470kΩ	
R18	0106273	27kΩ	
R01	0201821	820Ω	} 1W C.R.
R02	0201821	820Ω	
R09	0107681	680Ω	1/4W C.R.
VR01	1035490	1MΩ B	} Volume
VR02	1035310	1kΩ B	
	2410580	3P Pin Ass'y D type	1A

5-10. F-2509 Circuit Board for installing connector

(Stock No. 7592601 Complete Circuit Board F-2509)

Conductor Side

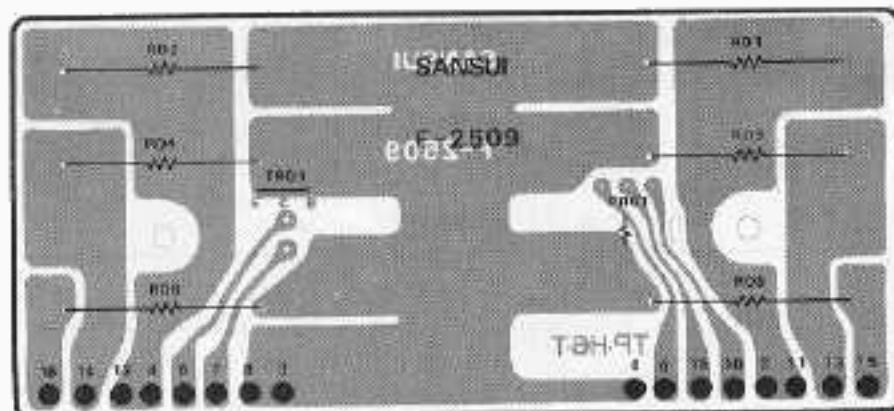

Parts List

Parts No.	Stock No.	Description
TR01	0306131-3	2SC1364 (6, 7, 8) Transistor
PR01	0320120	Posistor
R01	0135478	0.47Ω
R02	0135478	0.47Ω
R03	0135478	0.47Ω
R04	0135478	0.47Ω
R05	0135478	0.47Ω
R06	0135478	0.47Ω

5-11. Figures Semiconductors

SEMICONDUCTORS	COMPLETE CIRCUIT BOARD	SEMICONDUCTORS	COMPLETE CIRCUIT BOARD
2SA726 2SA847 2SA850 2SC1313 2SC1708 2SC1735	F-2513 F-2508 F-2507	10D-1	F-2511
2SA733 2SC1400 2SC1364 2SC945	F-2507 F-2511 F-2509 F-2515	VD1212	F-2515 F-2507 F-2508
2SD381	F-2508	1S2473	F-2511 F-2507 F-2515
2SA839 2SC1659 2SD382	F-2507 F-2508	RD-15E	F-2508 F-2507 F-2515
2SA818 2SC1628	F-2507	9G52TR(-) 9G52TS(+)	F-2511
TA7135	F-2515	1S1850(+) 1S1850R(-)	F-2511
2SA908 2SB554 2SC1585 2SD424	POWER TRANSISTOR		

Connector & Pin Ass'y

Connector

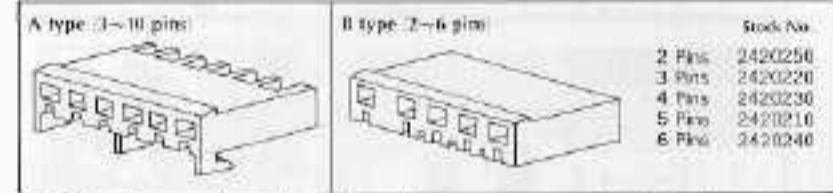

NOTE: Since stock number of female connectors (type B) with wires are not shown in each parts list of Complete circuit board, please refer to the above parts list when ordering the connector.

Pin Ass'y

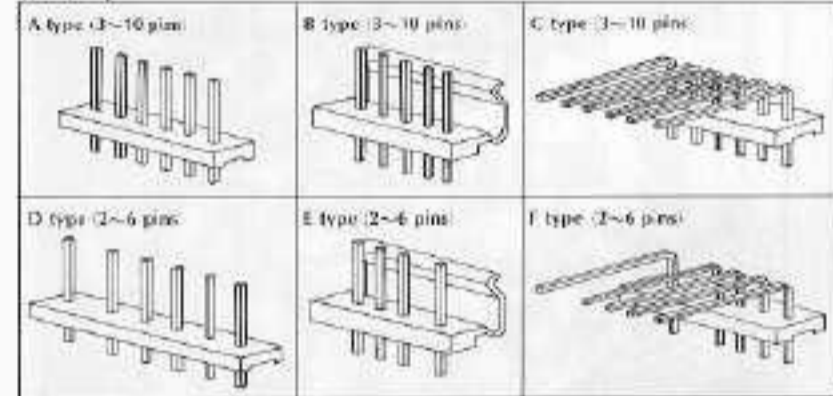

Abbreviations

- | | |
|---------------------------------|---|
| C.R. : Carbon Resistor | BP.E.C. : Bi-Polar Electrolytic Capacitor |
| S.R. : Solid Resistor | C.C. : Ceramic capacitor |
| Ce.R. : Cement Resistor | MI.C. : Mica Capacitor |
| M.R. : Metallized Film Resistor | O.C. : Oil Capacitor |
| M.C. : Mylar Capacitor | P.C. : Polystyrene Capacitor |
| E.C. : Electrolytic Capacitor | T.C. : Tantalum Capacitor |

5-12. Power Supply Voltage changeover

*In accordance with AC line voltage in your area, input AC voltages of this unit can be easily obtained by changing connections as shown in Fig. 5-1.

Fig. 5-1

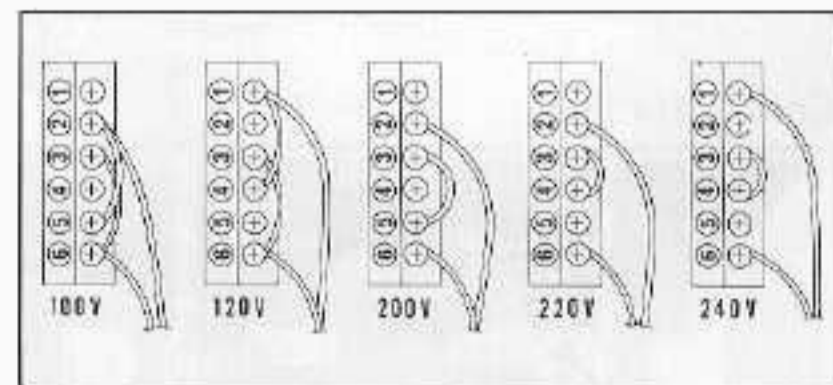
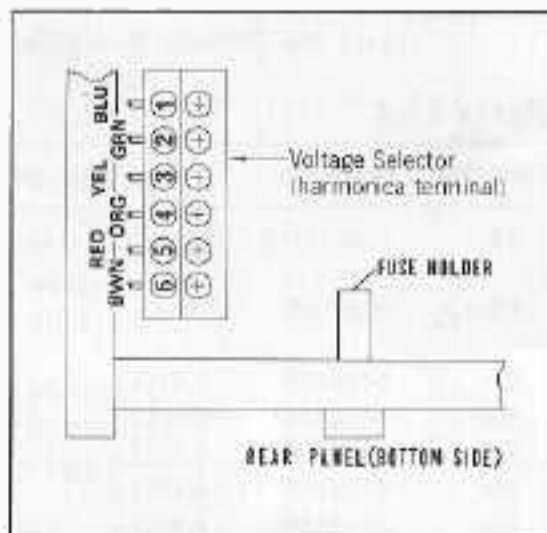

5-13. Other Parts (Top, Bottom Side)

Top Side

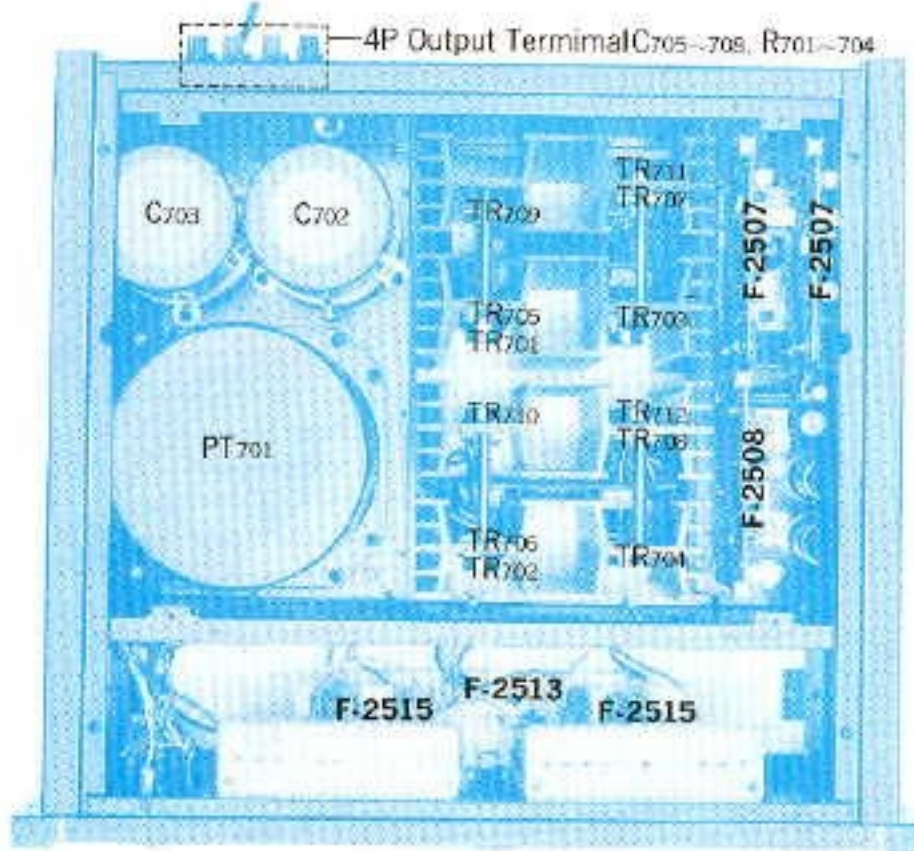

Bottom Side

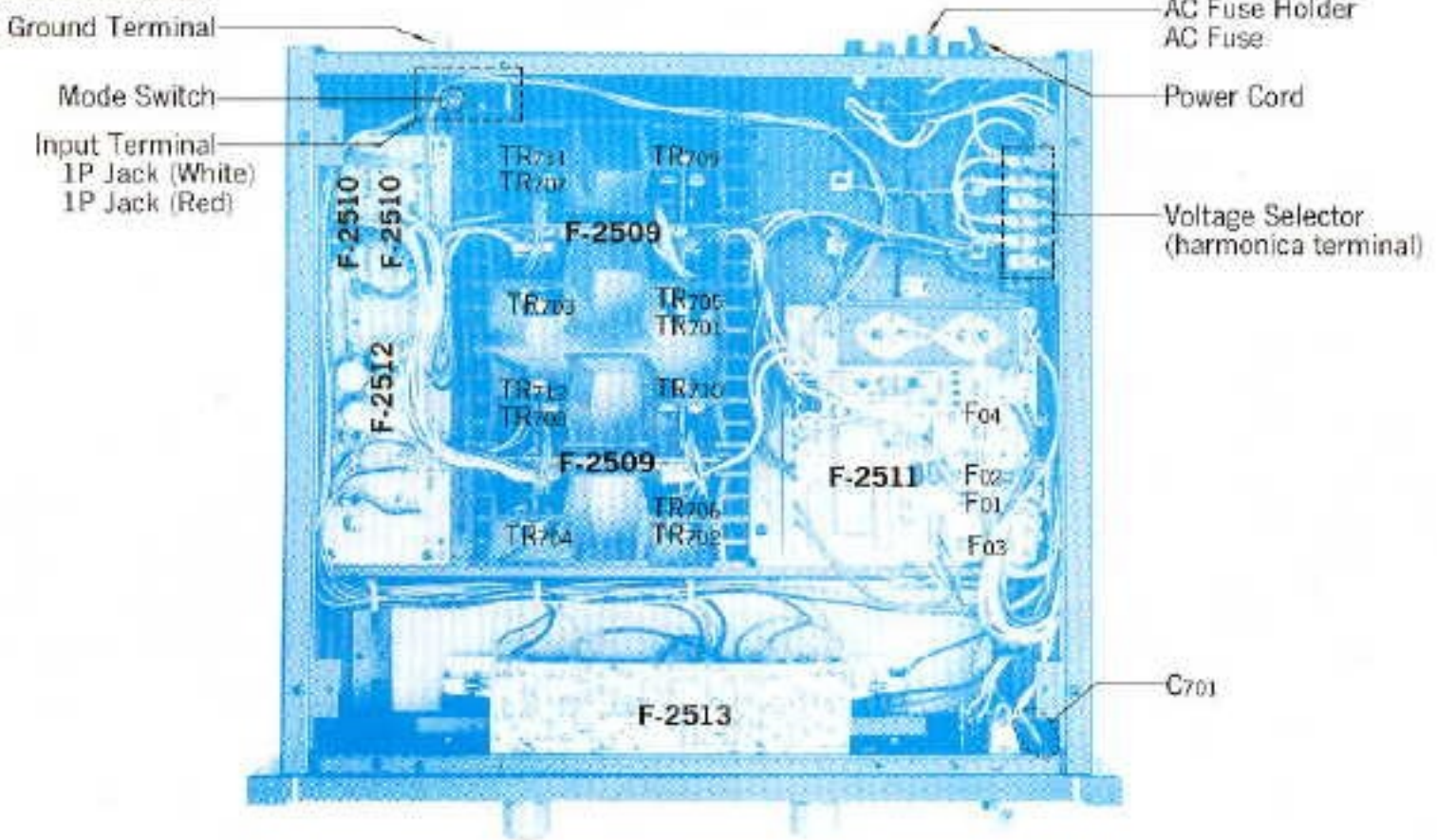

Other Part List

Parts No.	Stock No.	Description
TR701, 702	0366319-9 0388470-1	25C1585 E, O, Y 35D424 R, O
TR703, 704	0300730-2 0360380-1	25A908 E, O, Y 2510554 E, O
TR705, 706	0306310-2 0368470-1	25C1585 E, O, Y 35D424 R, O
TR707, 708	0300730-2 0300380-1	25A908 E, O, Y 2510554 E, O
TR709, 710	0306310-2 0368470-1	25C1585 E, O, Y 35D424 R, O
TR711, 712	0300730-2 0300380-1	25A908 E, O, Y 2510554 E, O
PT701	2030040 4602241	Power Transistor Socket Power Transformer
	2300040	Fuse Holder

Parts No.	Stock No.	Description
PT701	0431320	10A 250V AC Fuse (100V~120V)
	0431292	6A 250V AC Fuse (220V~240V)
	2230051	Ground Terminal
	2210280	4P Output Terminal
	2430260	1P Jack (White)
	2430270	1P Jack (Red)
	2450060	AC Caster
	3800050	Power Cord
	1110300	Mode Switch
C701	0659801	0.01μF 150V C.C.
C702	0559842	22000μF 80V E.C.
C703	0559842	22000μF 80V E.C.
C704-705	0651427	0.047μF 50V C.C.
R701-704	0104100	10Ω 1W C.B.
	2240040	Voltage Selector (harmonica terminal)

5-14. Other Parts (Front Side)

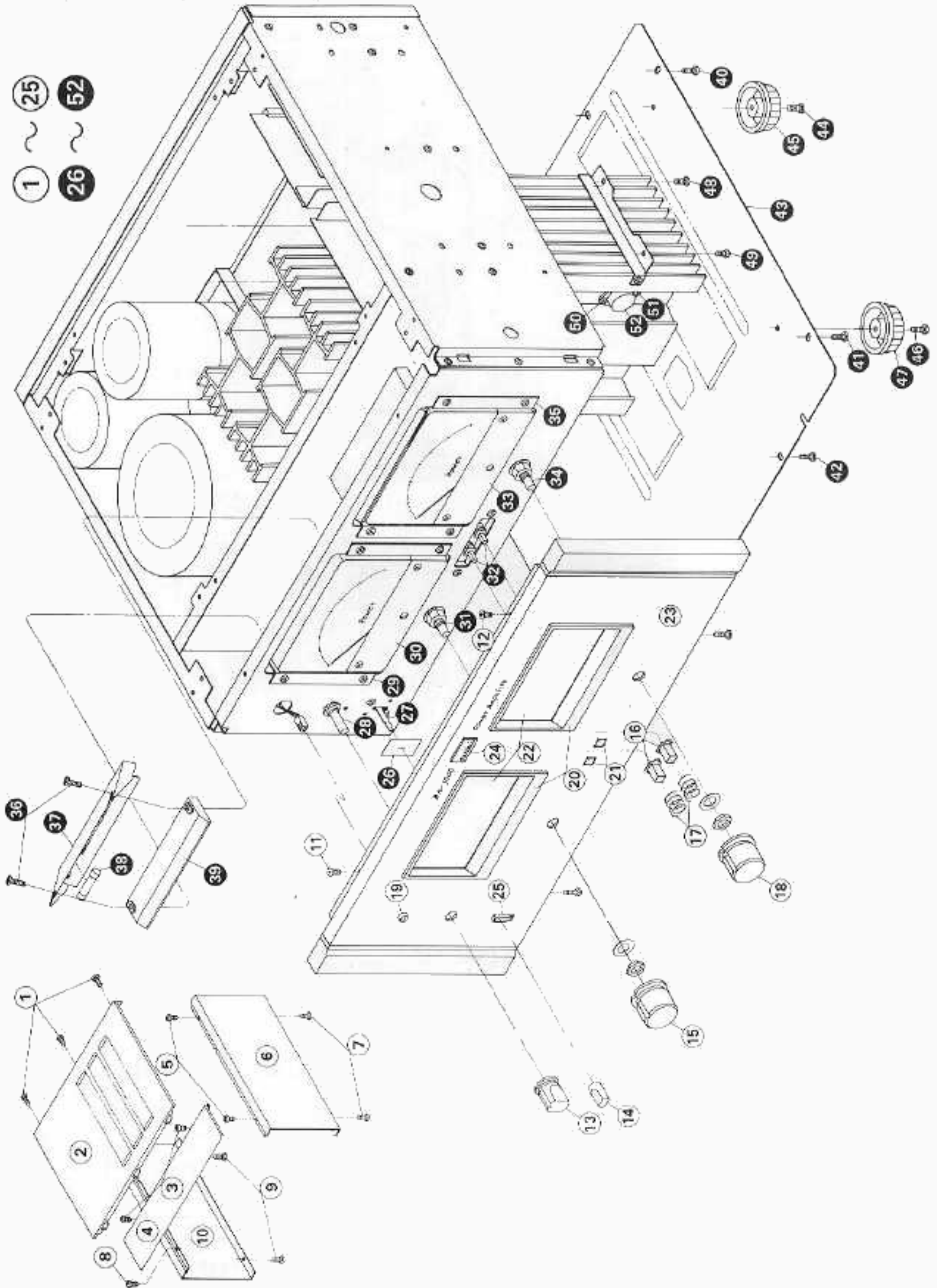

6. SCHEMATIC DIAGRAM

• La présentation et les spécifications sont susceptibles d'être modifiées sans préavis par suite d'améliorations éventuelles.
 • A nderung, die dem technischen Fortschritt dienen, bleiben vorbehalten.
 • Design and specifications subject to change without notice for improvements.

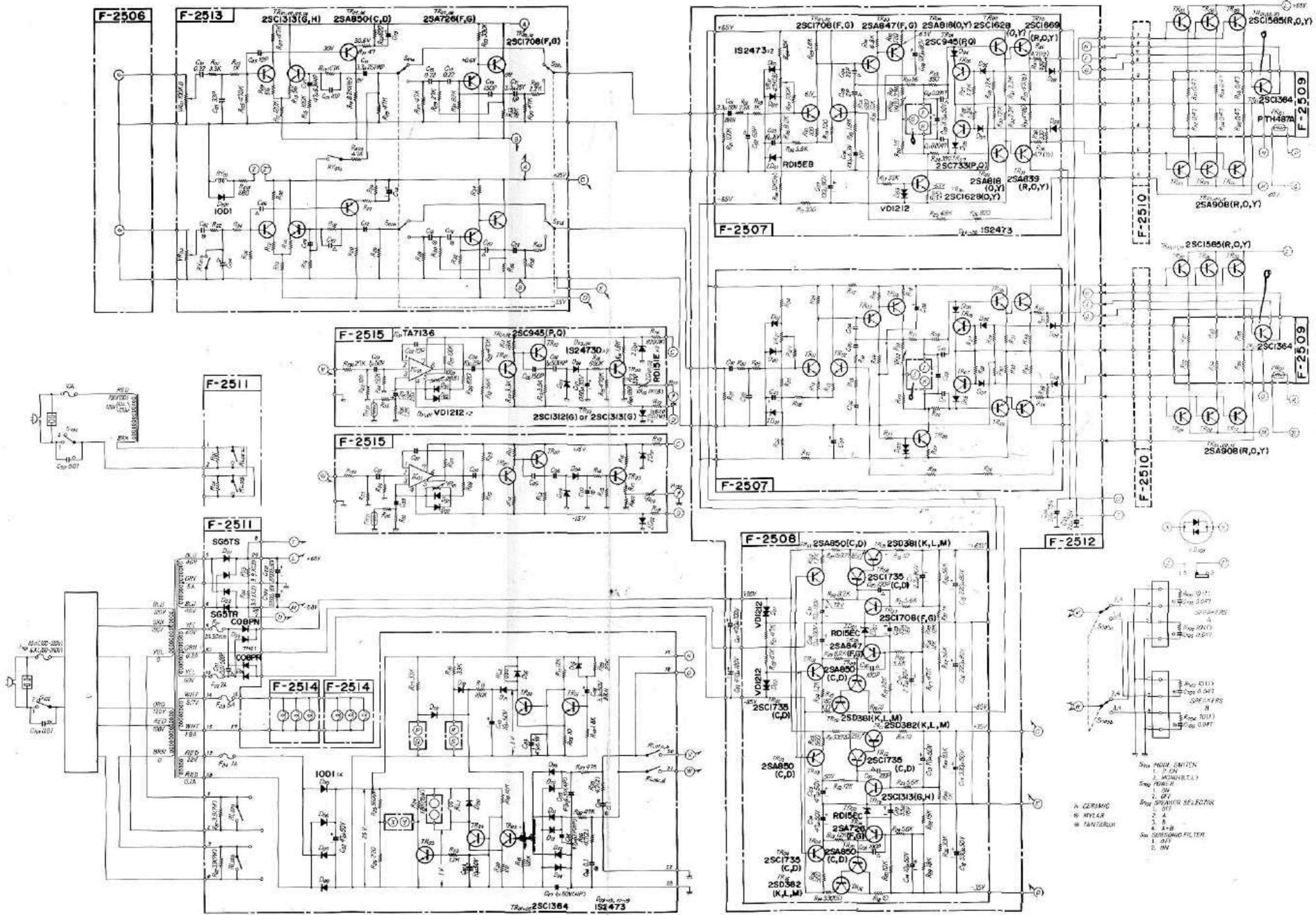

5-14. Other Parts List (Front Side)

Parts No.	Stock No.	Description
1	5109222	Binding Head Tapping Screw, M3×8
2	5006410	Banner (2)
3	5109222	Binding Head Tapping Screw, M3×8
4	5006400	Banner (1)
5	5109222	Binding Head Tapping Screw, M3×8
6	5309700	Dress Panel, Right
7	5109222	Binding Head Tapping Screw, M3×8
8	5109222	Binding Head Tapping Screw, M3×8
9	5109222	Binding Head Tapping Screw, M3×8
10	5309690	Dress Panel, Left
11	5102843	Flat Counter Sunk Head Screw, M3×6
12	5102843	Flat Counter Sunk Head Screw, M3×6
13	5318280	F-6 Type Knob, Speaker Switch
14	5326510	E-2 Type Knob, Power Switch
15	5318240	A-6 Type Knob, Left Level Volume
16	5326530	Push Knob
17	6906480	Spring, Push Knob
18	5318240	A-6 Type Knob, Right Level Volume
19	7726120	LED Ass'y, Power Protector Indicator
20	5309740	Meter Hood
21	5286720	Knob Guide
22	5446220	Meter Glass
23	7007070	Front Panel Ass'y
24	5336580	Sansui Mark
25	5286730	Lever Guide
26	5047460	Masking, Lever Switch
27	1170330	Lever Switch, Power Switch (S702)
28	1102630, 1	Y-2-4-4, Speaker Switch (S703)
29	5286640	Meter Holder Plate
30	4300830	Power Meter
31	1000330, 1	Level Volume 100kΩB
32	1131090	Subsonic Filter Switch
33	4300830	Power Meter
34	1000330, 1	Level Volume, 100kΩB
35	5286640	Meter Holder Plate
36	5101047	Binding Head Screw, M3×14
37	5286691	Illuminator Cover
38	0420040	Meter Lamp, 7V 320mA
39	5446230	Illuminator Plate
40	5109222	Binding Head Tapping Screw, M3×8
41	5109222	Binding Head Tapping Screw, M3×8
42	5109222	Binding Head Tapping Screw, M3×8
43	5058380	Bottom Plate
44	5101047	Binding Head Tapping Screw, M3×14
45	5517050	Leg
46	5101047	Binding Head Screw, M3×14
47	5517050	Leg
48	5109222	Binding Head Tapping Screw, M3×8
49	5109222	Binding Head Tapping Screw, M3×8
50	5109222	Binding Head Tapping Screw, M3×8
51	5109222	Binding Head Tapping Screw, M3×8
52		Power Transistor

7. PACKING LIST

Parts No.	Stock No.	Description
1	9116650	Vinyl Cover
2	9027890	Styrofoam Packing
3	9008310	Carton Case
4	5996080	Carf Stopper

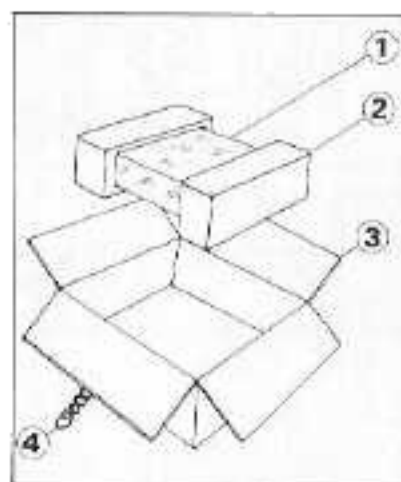

8. ACCESSORY PARTS LIST

Parts No.	Stock No.	Description
1	9208870	Operating Instruction
2	9208760	Schematic Diagram



SANSUI ELECTRIC CO., LTD.
 14-1, 2-chome, Izumi, Suginamiku, Tokyo 168, Japan.
 TELEPHONE: (03) 323-1111 / TELEX: 232-2076